



MPPT CHARGE CONTROLLER

USER MANUAL

Solar Mate





5min

WARNING: HIGH VOLTAGE INSIDE

CAUTION: THE DC BREAKER MUST HAVE BEEN TURNED OFF BEFORE SERVICING

MADE IN CHINA

Preface

Thank you for choosing the SP series MPPT solar charge controller which is safe and reliable in design and usage. This manual includes information on the solar controllers' electrical performance and protection mechanisms. Please read this manual carefully before installing and operating the controller. Following the guidelines outlined in this manual will extend the controllers service life.

The installation, operation, and maintenance of this series of controller should be carried out by trained technical person. The following requirements MUST be verified:

- PV input voltage MUST be less than the nominal working voltage of the controller.
- Please ensure that the positive and negative of the DC output are correctly connected; Avoid the reverse polarity on the BAT.
- Please ensure that the connection cable between the controller and the battery is as short as possible and avoid short circuit on the connection.
- There are no internal parts that are field serviceable. Disassembling the controller will VOID warranty.

Statement:

Please understand due to the continuous update and improvement of products and technology, the manufacturer reserves the right to make changes to the product at any time.

Content

1. General Safety Instruction	1
1.1 Safety Instruction.....	1
1.2 General Precaution.....	1
1.3 Precaution regarding battery operation.....	1
2. Introduction	2
2.1 Brief Introduction	2
2.1.1 General Description	2
2.1.2 Model Name Rule.....	2
2.2 Appearance	3
2.2.1 Front View	3
2.3 Connectors & Ports	3
2.4 Dip Switch.....	4
2.5 Dimension.....	6
2.6 Functions	6
2.6.1 Maximum Power Point Tracking	6
2.6.2 Multistage Charging Algorithm	6
2.6.3 Battery Temperature Compensation	7
2.6.4 System Integration Interface	8
2.6.5 Protections	8
2.6.6 Multiple machines in parallel.....	9
2.6.7 Forced Charging.....	9
3. Installation	10
3.1 Pre-installation Inspection	10
3.1.1 Packing Inspection	10
3.2 Select installation location.....	10
3.2.1 Installation Position Requirements.....	10
3.2.2 Installation Space Requirements	10
3.3 Installation Guide.....	11
3.4 Preparation Before Wiring	11
3.4.1 PV module configuration	11
3.4.2 Circuit Breaker Preparation.....	12
3.4.3 Cable Preparation	13
3.4.4 Single Unit Wiring.....	13
3.4.5 Multiple Unit Wiring	14
4. Start up and Run	16
4.1 Check Before Operation	16
4.2 Start-up Inspection	16
4.3 Power OFF	16
5. Maintenance	17
5.1 Routine Maintenance.....	17
5.2 Quick Fault Inspection.....	17
6. Specification	19

1. General Safety Instruction

1.1 Safety Instruction

As dangerous voltage and high temperature exist within the charge controller, only qualified and authorized maintenance personnel are permitted to open and repair it.

This manual contains information concerning the installation and operation of the charge controller. All relevant parts of the manual should be read prior to commencing the installation. Please follow the local stipulation meantime.

Any operation against safety requirement or against design, manufacture, safety standard, are out of the manufacturer warranty.

1.2 General Precaution

- Do not expose to rain, snow or liquids of any type, it is designed for the indoor use.
- This solar controller must be installed in a dry location. Ventilation requirements must also be met to prevent the controller from overheating.
- To avoid fire and electric shock, please ensure all cables are properly sized, and have good insulation. Do NOT use damaged or undersized cables.
- Do not install controller near flammable or explosive material.
- Never touch uninsulated cable ends.
- Use only insulated tools.
- In final usage, an isolation measure can be implemented on communication port for extra level safety.

1.3 Precaution regarding battery operation

- If the skin and clothing are contaminated with battery acid, wash them immediately with soap and water. If acid splashes into eyes, flush with cold water for at least 20 minutes and seek medical attention immediately.
- Do not smoke or set a fire near the battery or engine.
- Do not place metal tools on the battery, otherwise there is a risk of explosion caused by sparks or short circuit.
- Do not wear jewelry such as rings, bracelets, necklaces, watches, etc. when operate the battery. The short-circuited current will generate high heat, which can melt metal objects and cause severe burns.

2. Introduction

2.1 Brief Introduction

2.1.1 General Description

With MPPT technology, the SP series solar charge controller enables maximum energy tracking for solar charging. This technology allows the controller to track the maximum power point of an array quickly and accurately in any environment, obtain the maximum energy of solar panel in real time, and charge the battery at maximum current.

The controller has a built-in multi-stage battery charging algorithm, along with an MPPT algorithm that allows for wide voltage input ranges. This makes this controller suitable for charging various types of batteries, including GEL, AGM, LFP, and WET batteries. The main features are as follows:

- Wide MPPT voltage range
- High MPPT efficiency, the Max. efficiency≥99.9%
- Built-in battery temperature compensation feature
- Support RS485, CAN and Bluetooth communication
- Low self-consumption on battery: 1mA@12VDC,3mA@24VDC
- Support wide operation temperature, charging during -40~70°C
- Support 365 days real-time data recording, event recording and power statistics
- Nature cooling design without noise

2.1.2 Model Name Rule

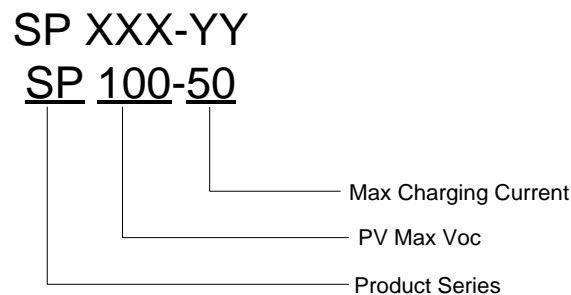

Field	Character	Description	
SP	SP	Solar Mate Series MPPT Solar Charge Controller	
XXX	100	PV Max open circuit voltage (V)	100V
YYY	50	Max. output current (A)	50A
	30		30A

e.g. SP100-50 is a MPPT charge controller with BT; max. Voc at 100V, max. output current at 50A.

2.2 Appearance

2.2.1 Front View



Figure 2-1 MPPT Solar Charge Controller Front View

Table 2-1 LED Indicator Description

LED	Function Description
Run	<ul style="list-style-type: none"> ● Flash during standby ● Steady On during charging
Warning	<ul style="list-style-type: none"> ● Flash during warning
Fault	<ul style="list-style-type: none"> ● Flash during fault and stop charging

2.3 Connectors & Ports



Figure 2-2 Connectors & Ports

Table 2-2 Connectors & Ports Definition

No.	Print		Function
1	PV	+	PV "+" input
2		-	PV "-" input
3	BAT	+	Battery "+" output
4		-	Battery "-" output
5	COM		RS485 communication port
8	RV-C		RV-C communication connector
9	Addr		Instance setting
10	Temp		Temperature sampling connector

Table 2-3 COM Port Definition

PIN	Designation
1	--
2	--
3	RS485_A
4	--
5	--
6	RS485_B
7	+12V
8	0V

Table 2-4 RV-C Connector Definition

PIN	Designation
1	CAN_H
2	CAN_L
3	--
4	--

2.4 Dip Switch

Table 2-5 Addr Definition

Status		Instance
PIN 1	PIN 2	
OFF	OFF	1
OFF	ON	2
ON	OFF	3
ON	ON	4



Figure 2-3 Dip Switch in Connection Compartment

Table 2-6 Dip Switch in Connection Compartment Definition

Status		Definition
PIN 1	PIN 2	
OFF	OFF	GEL
OFF	ON	AGM
ON	OFF	LFP
ON	ON	WET

2.5 Dimension

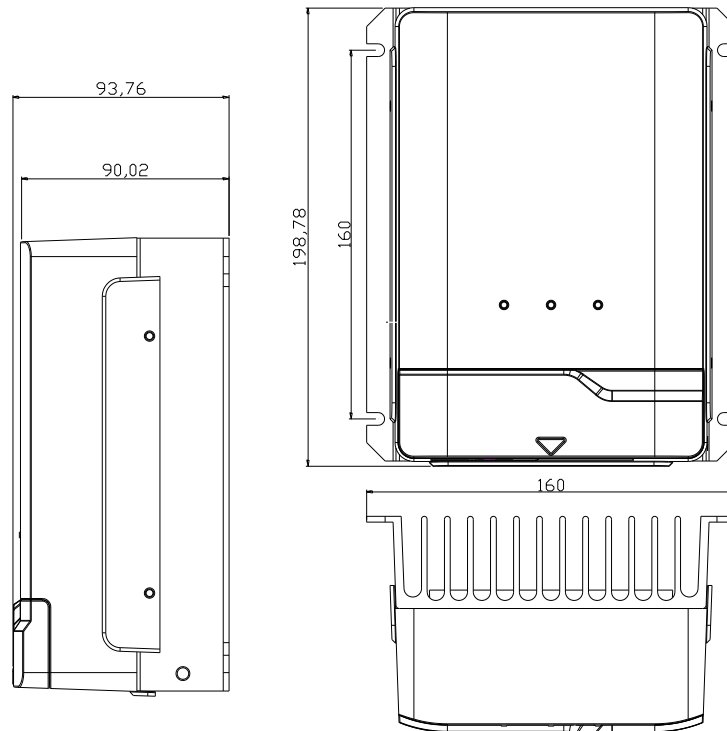

Figure 2-4 Dimension of SP Controller

2.6 Functions

2.6.1 Maximum Power Point Tracking

Photovoltaic output power is determined by the intensity of light irradiation and weather and climate, and the maximum power point of photovoltaics varies greatly under different weather and climate.

The maximum power point tracking technology can maximize the energy harvested from the photovoltaic array to charge the battery. The MPPT software algorithm will continuously adjust according to the light intensity and climate change, find the maximum power point of the photovoltaic array, and effectively use the energy of the photovoltaic array.

2.6.2 Multistage Charging Algorithm

The SP is designed with multi-stage charging algorithm, bulk-absorption-float-recycle, which can ensure that the battery is fully charged quickly. Float and cycle charging options ensure the battery is properly maintained during extended connection time.

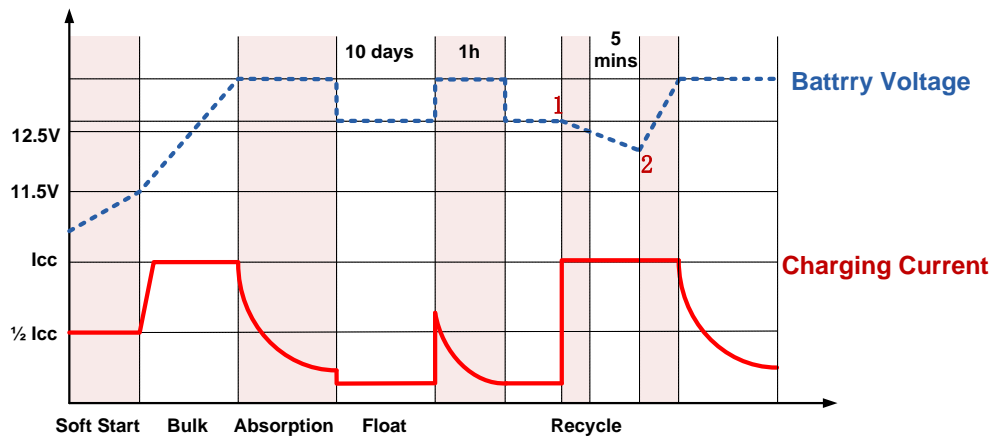

Figure 2-5 Standard battery charging curve

Note1: At this moment, the external load current of the battery is greater than the maximum charging current of the controller and the battery voltage starts to drop.

Note2: When the battery voltage is lower than 12.5V for 5 minutes, the charging state of the controller changes from floating charging to constant current charging. At this moment, the external load current of the battery is less than the maximum charging current of the controller, and the battery voltage starts to rise.

2.6.3 Battery Temperature Compensation

Battery temperature is a key factor affecting battery charging. The battery charging voltage must be adjusted in real time according to the battery temperature to ensure that the battery is fully charged and will not be overcharged or undercharged. Battery temperature compensation range is $-10^{\circ}\text{C}\sim 50^{\circ}\text{C}$.

BTS (battery temperature sensor) can measure the battery temperature, and the SP series controller can adjust the charging voltage in real time according to the measured battery temperature. The temperature compensation is based on 25°C , and the default compensation coefficient is $-3\text{mV}/^{\circ}\text{C}/\text{cell}$.

The factory default setting on battery temperature compensation function is “OFF” status. The user can enable this feature on the APP and the temperature compensation coefficient can be set as well. For details, check the APP parameter settings.

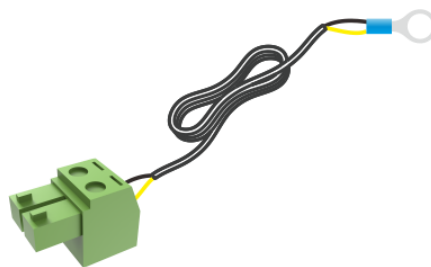

Figure 2-6 BTS (battery temperature sensor)

Note: BTS is an optional accessory.

Battery Type

There are various types of batteries, and the absorption charge voltage and floating charge voltage of different batteries are different. The SP controller can support the charging of GEL, AGM, LFP, WET and other batteries. You can set the battery type, maximum charging current, absorption charging voltage, floating charging voltage, etc. on the APP according to different batteries to match different battery types and ensure the battery can be charged accurately without overcharging or undercharging.

2.6.4 System Integration Interface

RS485 communication

The SP controller supports RS485 communication, and can accept centralized monitoring of the system through the COM interface to view real-time information.

CAN communication

The SP controller supports CAN communication, and can accept centralized monitoring of the system through the RV-C interface to view real-time information.

Bluetooth Communication

The SP controller supports bluetooth communication, monitoring can be carried out through mobile APP.

2.6.5 Protections

PV input reversed polarity protection

When the polarity of PV array is reversed, the controller will shut down; the short circuit current **can't** exceed Max. PV short circuit current (See Table 3-1); the normal operation will continue after wiring error is corrected.

PV overvoltage protection

When the PV voltage of the SP controller is too high and exceeds the operable voltage range, the controller will turn off the output and prompt with an audible and visual alarm.



When the PV voltage exceeds the maximum PV open circuit voltage range, beyond specification use may cause damage to the controller. Any damage caused by the user's improper operation will VOID warranty.

Output short circuit protection

When the PV input power is within the limit, and the output is short-circuited, the controller will reliably protect and give an alarm. After the short-circuit fault is removed, the controller will resume normal charging.

Controller over temperature protection

When the internal temperature of the controller exceeds the threshold (the parameter sheet as reference), the controller will derate and reduce the output power. When the external environment temperature is too high and the internal environment temperature still exceeds the threshold after derating, the controller will turn off the output to prevent internal damage.

Max. charging current

Derating Curve

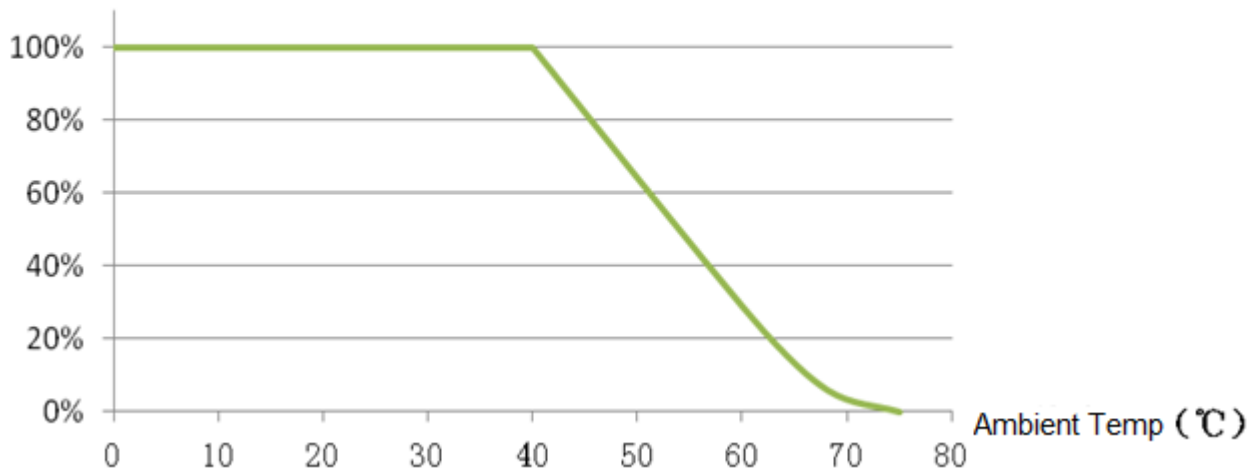

Figure 2-7 SP100 Series Ambient temperature derating curve

Battery over temperature protection

During the charging process, the controller will sample the battery temperature in real time when the battery temp sensor is connected and enabled. Once the battery temperature is too high, the controller will reduce the charging current until shutting down; a fault alarm will be prompted to protect the battery from over temperature.

2.6.6 Multiple machines in parallel

Through the RV-C ports, SP controller can support 4 devices wired in parallel.

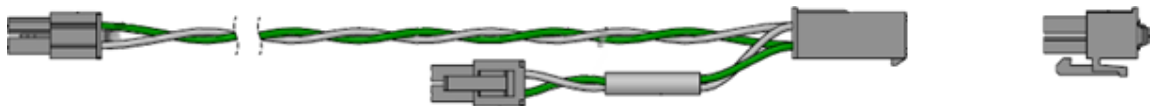

Figure 2-8 Parallel Cable

2.6.7 Forced Charging

The SP controller has a forced charging function, which is turned on by default when it is set to the LFP lithium battery mode, and can be turned on manually for other battery types. When the SP battery side is connected to the battery, the battery will be charged after 30s. When the battery is not connected, the battery side will start the output after 5.5 minutes. If the PV energy is not enough to maintain the output voltage at this time, the output will be cut off and 30 minutes later to output again.

3. Installation

3.1 Pre-installation Inspection

3.1.1 Packing Inspection

- Before unpacking, please check whether the outer packaging is damaged and whether the controller model is correct. If there is any abnormality, please contact your dealer.
- After unpacking, please check whether the number of accessories is complete and whether the accessories are damaged. If there is any abnormality, please contact your dealer.

Package		
No.	Component	Qty
1	SP Controller	1
2	Manual	1

3.2 Select installation location

3.2.1 Installation Position Requirements

- Indoor installation only.
- Do not install the controller near flammable or explosive items.
- During the operation of the controller, the temperature of the chassis and radiator will be relatively high. Please do not install it in the place where it is easy to touch.
- The controller should be installed in a well-ventilated area.
- Ensure that the mounting surface is strong enough for reliable installation.



Do not install the SP in a sealed compartment with batteries.

3.2.2 Installation Space Requirements

The controller **MUST** have adequate room on all sides for air flow. Refer to figure 3-1 for minimum spacing requirements.

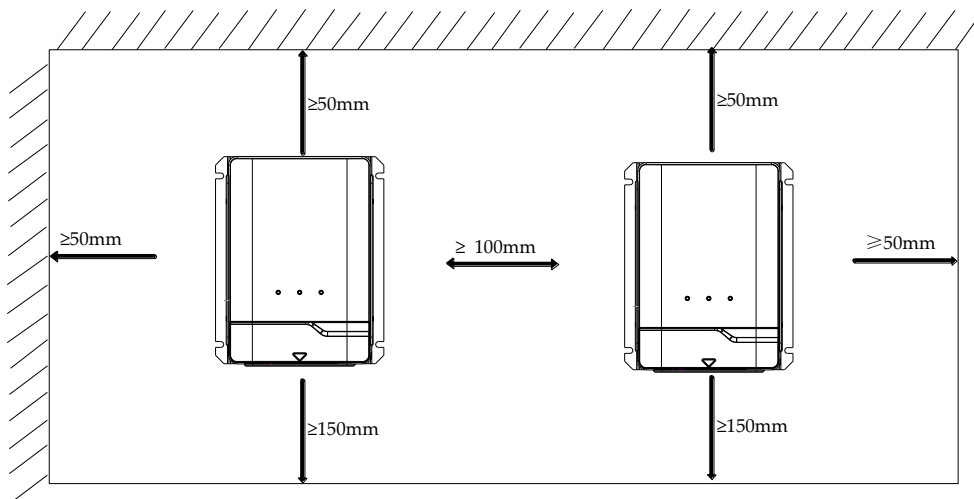

Figure 3-1 Minimal Installation Distance

3.3 Installation Guide

- Ensure the controller is flush on mounting material. Drills the holes based on the lock hole requirements. See Figure 3-2; lock hole size: 160*150mm, 4*φ5.5.

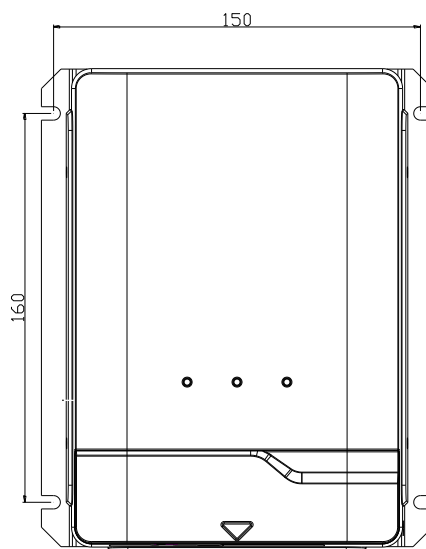

Figure 3-2 Lock Hole

- Please install the SP controller as close to the battery as possible to reduce the voltage drop and line loss between the controller and the battery. It supports horizontal and vertical installation, prefer vertical installation way.



Make sure all screws of the controller are firmly locked and the controller is installed well.

3.4 Preparation Before Wiring

3.4.1 PV module configuration

Each SP controller must be connected to one PV module separately. Please configure and connect the photovoltaic modules according to the maximum specifications of the PV as shown in table 3-1.

Table 3-1 SP PV Module Configuration Requirements

		SP100-50	SP100-30
Max. PV open circuit voltage		100V	100V
Max. MPPT voltage range		(Vbat+6VDC)~90VDC	
Max. PV short circuit current		50A	30A
Max. PV input power	12VDC	800W	500W
	24VDC	1600W	1000W

- The maximum PV short-circuit current allowed by the controller is referred to the table above. When configuring PV modules, please ensure that the maximum short-circuit current of PV modules is less than the Max. PV short circuit current.
- Please ensure that the configuration of the PV module is correct and the positive and negative wiring is correct.
- Please ensure that the maximum open-circuit voltage output of the PV module is within the MPPT voltage range, the controller can be charged normally.

3.4.2 Circuit Breaker Preparation

- A fuse or circuit breaker with current greater than 120% of the rated current must be connected to the battery side of the controller.
- Please refer to Table 3-2 for the specification requirements of the DC circuit breakers on the battery side.

Table 3-2 Breaker requirements

No.	Parts	Model	Requirement
1	Battery Breaker	SP100-50	Rated current requirement $\geq 60A$.
		SP100-30	Rated current requirement $\geq 40A$.

3.4.3 Cable Preparation

- The temperature resistance of the wire is required to be greater than 90°C (194°F)
- Wire diameter requirements, see Table 3-3.

Table 3-3 DC Wire Requirement

Current	Minimum Wire Diameter			
	6.5 feet		10 feet	
30A	10AWG	6mm ²	8AWG	10mm ²
40A	8AWG	10mm ²	6AWG	16mm ²
50A	6AWG	16mm ²	6AWG	16mm ²

3.4.4 Single Unit Wiring

Perform the following steps to connect cables.

- Step 1: Shown as figure 3-3, remove wiring cover plate.
- Step 2: Select the appropriate wire according to section 3.4.3, make sure the breaker in the OFF status before wiring.
- Step 3: Connect BAT- to battery negative terminal, and connect BAT+ to battery positive terminal, see figure 3-4.
- Step 4: Connect PV- to PV panel negative port, and connect PV+ to PV panel positive port, see figure 3-4.
- Step 5: Make sure the wire is connected correctly and reliably.
- Step 6: After the wiring connection, cover the plate to the connection compartment.



Figure 3-3 Remove wiring cover plate

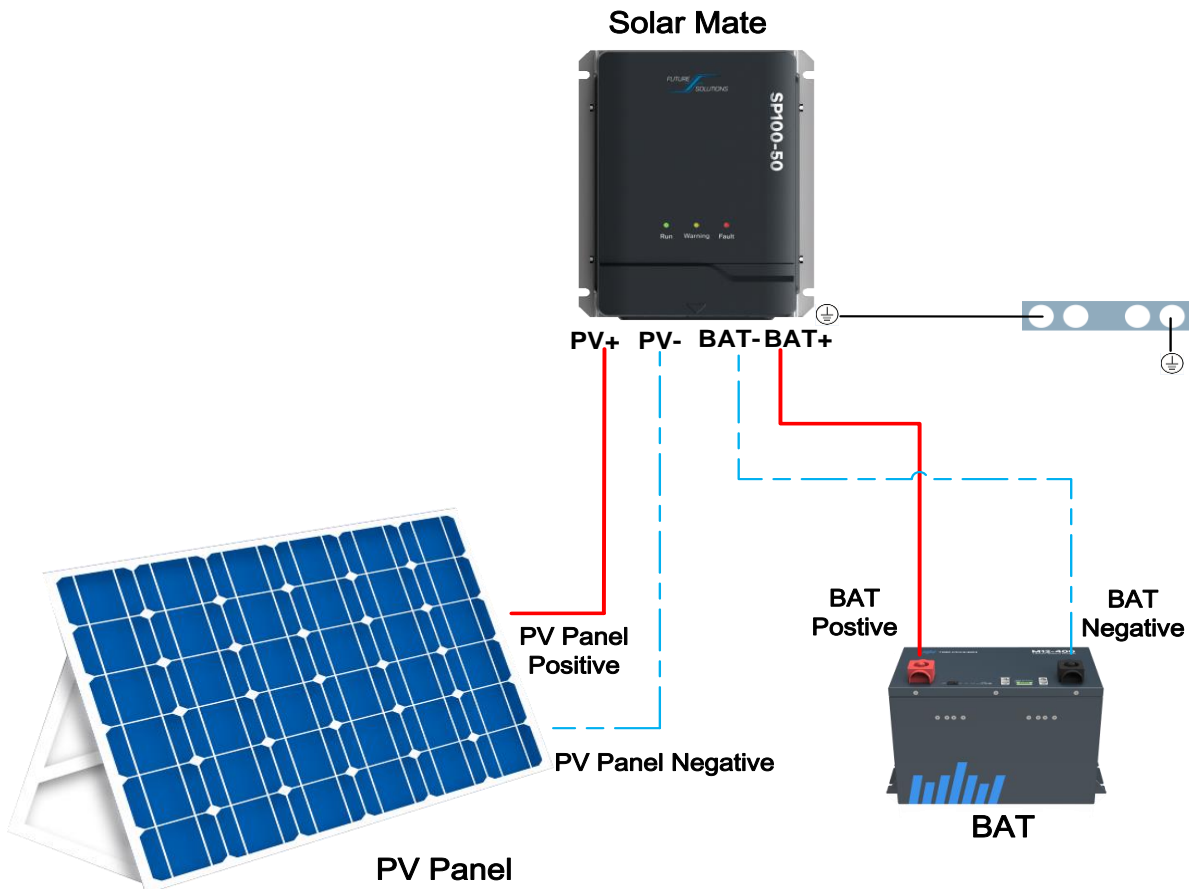

Figure 3-4 SP Single Unit Wiring

3.4.5 Multiple Unit Wiring

The following figure 3-5 setup is the largest configuration which is used to connect up to 4 SP controller to charge the battery pack. The controllers use parallel communication cables for communication, which can be centrally monitored by the system. When used in parallel, the addresses of devices need to be set to 1~4 through the Addr dip switch.

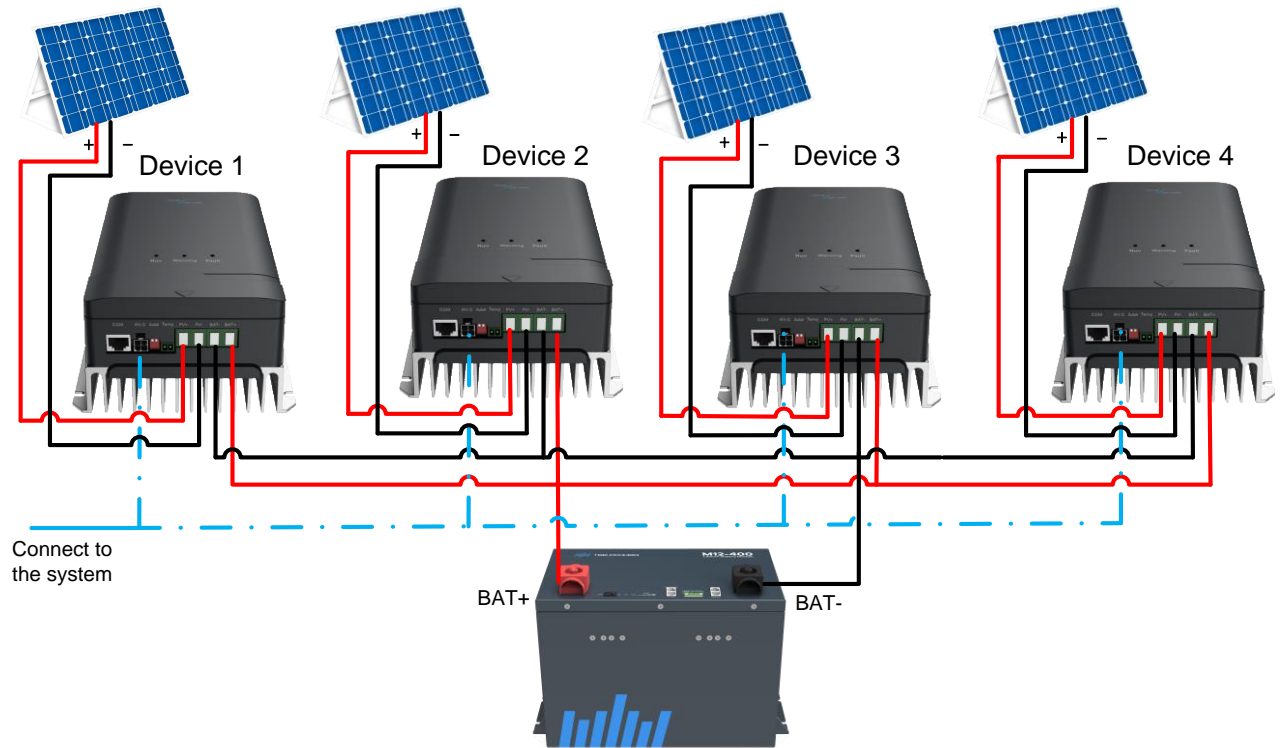

Figure 3-5 SP Parallel Wiring

4. Start up and Run

4.1 Check Before Operation

Please check the following items before starting up:

- The SP controller is installed correctly and securely, with a clean installation environment and sufficient space.
- Cable routing and layout are correct.
- Make sure the ground connection is correct and reliable.
- Please make sure that the battery circuit breaker is open.
- Please ensure that the wiring between the battery and PV is correct and secure.

4.2 Start-up Inspection



Please make sure that the battery voltage and PV module voltage do not exceed the SP controller specifications.

Follow the steps below to start up:

- Step 1: Close the circuit breaker between the battery and the SP controller.
- Step 2: After waiting for 30 seconds, observe the running information on the LED indicator to confirm that the device is charging normally.

4.3 Power OFF



After the MPPT controller is power OFF, there is still residual power and heat in the chassis, which may lead to electric shock or burn. Therefore, after the MPPT controller is powered off for 5 minutes, you should wear protective gloves before removed the MPPT controller.

Please turn off the circuit breaker between the battery and the MPPT controller.

5. Maintenance

5.1 Routine Maintenance

In order to ensure the long-term good operation of the SP controller, this chapter mainly introduces the routine maintenance requirements.

Object	Method	Maintenance cycle
Cleaning	Check whether the SP controller panel is clean	Half a year or once a year
Operation	<ul style="list-style-type: none"> ➤ The appearance is clean ➤ There is no abnormal sound during the operation ➤ The parameters are correct during operation 	Once a year
Wiring	<ul style="list-style-type: none"> ➤ Wiring connection is firm ➤ The cable insulation shall be free from damage and aging 	Half a year or once a year
Grounding	The ground wire is firmly connected	Half a year or once a year

5.2 Quick Fault Inspection

Fault level definition:

- Fault: The SP controller has a serious fault and cannot continue charging and the Fault light flashes.
- Warning: The SP controller is abnormal, and the Warning light flashes.

Type	Code	Name	Description	Fault LED	Troubleshooting
Fault	01	U_Bus_OV	PV voltage is too high	Flash 1 time	<ul style="list-style-type: none"> ➤ Check the string of PV array. ➤ Make sure the PV open circuit voltage lower than the maximum range of MPPT controller. ➤ If it happens frequently, please contact your dealer.
	02	U_BAT_OV	Battery over voltage	Flash 2 times	<ul style="list-style-type: none"> ➤ Check whether the controller matches to the battery voltage. ➤ If it happens frequently, please contact your dealer.
	03	U_Bat_OV_HD		Flash 3 times	
	04	Buck_ShortCut	Battery short circuit	Flash 4 times	<ul style="list-style-type: none"> ➤ Check and restore the wiring to see if the controller can operate normally. ➤ If there is no wiring error, please contact your dealer.

	05	I_Buck1_OC	Output over current	Flash 5 times	<ul style="list-style-type: none"> ➤ Check the output connection. ➤ If there is no wiring error, please contact your dealer.
	07	T_Board_OT	Over-temperature inside	Flash 7 times	<ul style="list-style-type: none"> ➤ Check whether ambient temperature is over limitation of the controller. ➤ Check the installation ambient ventilation. ➤ If the ambient temperature and ventilation is normal, please contact your dealer.
	09	PSU_LV	Auxiliary power under-voltage	Flash 9 times	<ul style="list-style-type: none"> ➤ Please contact your dealer.
	10	PSU_LV_HD		Flash 10 times	
	11	Sam_HD_Fault	Sampling failure	Flash 11 times	
	12	EEPROM_Fail	ROM abnormal	Flash 12 times	

Type	Code	Name	Description	Warning LED	Troubleshooting
Warning	04	BAT_UnConnect	Battery connection failure	Flash 4 times	<ul style="list-style-type: none"> ➤ Check whether the battery circuit breaker is off. ➤ Check whether the battery power cable in good connection.
	06	T_BAT_OT	Battery over temperature	Flash 6 times	<ul style="list-style-type: none"> ➤ Check whether the installation ambient temperature is too high. ➤ Check whether the battery wiring is tight and reliable. ➤ Check whether the battery cable matches the requirement.
	08	TypeSet_Mismatch_Err	The controller model error	Flash 8 times	<ul style="list-style-type: none"> ➤ Check whether the model is correct. ➤ Please contact your dealer.
	14	NTC_Board_Fault	The NTC of the controller is fault	Flash 14 times	<ul style="list-style-type: none"> ➤ Please contact your dealer.

6. Specification

		SP100-50	SP100-30
Electrical			
Nominal battery voltage		12/24VDC	
Maximum charging current		50A	30A
Maximum charging power	12VDC	735W	441W
	24VDC	1470W	882W
	48VDC	NA	NA
Maximum PV input power	12VDC	800W	500W
	24VDC	1600W	1000W
	48VDC	NA	NA
Max. PV open circuit voltage		100VDC	
PV Start voltage		21V±5V@12VDC/ 33±5V@24V	
MPPT voltage range		(Vbat+6VDC)~90VDC	
Max. PV short circuit current		50A	30A
Max efficiency		≥97%	
Max MPPT efficiency		≥99.9%	
Self-consumption		Less than 1mA@12VDC/ 3mA@24VDC	
Charge voltage 'absorption'		Default setting: 14.1VDC/28.2VDC	
Charge voltage 'float'		Default setting: 13.5VDC/27VDC	
Temperature compensation		Default setting: -3mV/°C/cell	
Others			
Display		LED indicator	
Communication		RS485, CAN, Bluetooth	
Data logging		365-day historical records, including daily, monthly, annual power generation, total power generation records, historical operation event records, user operation logs, etc.	
Storage temperature		-40~70°C	
Operating temperature		-40~70°C (power derating over 40°C)	
Humidity		5%~95% non-condensing	
Altitude		3000m (>2000m power derating)	
Max wire sizes		16 mm ²	
IP rating		IP20	
Dimension (mm)		199*160*94	199*160*74
Weight		1.85kg	1.4kg
Cooling		Natural cooling	

Future Sales LLC

 info@fsi-solutions.com

 www.fsi-solutions.com

 (574) 262-3688